



VISIO 2:1

USER MANUAL (ENGLISH)

RAIS[®]

attika[®]
FEUERKULTUR

PRODUCTION NUMBER

Congratulations on your fireplace insert. Each stove has its own unique production number. The production number is located on the side of the frame behind the door, but it can also be found below. The number is the stove's identification and must be used in case of any enquiries related to the stove's warranty - so you have all the information together in case of any enquiries.

INSERT
PRODUCTION NUMBER

THIS MANUAL APPLIES TO THE FOLLOWING MODELS:

- Visio 2:1

Visio 2:1



PRODUCTION NUMBER	2
USER MANUAL	4
WOOD	5
Use approved fuels only	5
The wood must be dry	5
Your wood must fit the stove	5
FIRING	6
Recommended amount of wood for stroking the fire	6
Do not overfire	6
Lighting your stove for the first time	6
SETTING THE DAMPER	7
Manual air damper adjustment	7
LIGHTING YOUR STOVE CORRECTLY	8
DISTANCE TO FURNITURE	11
COMBUSTION CHAMBER	12
Cleaning the flue	12
Removing the combustion chamber lining	13
CLEANING YOUR STOVE	14
Cleaning the outside of your stove	14
Cleaning the combustion chamber	15
Cleaning the glass	16
MAINTAINING YOUR STOVE	17
NOMINAL TEST	18
TECHNICAL DATA	20
GENERAL INFORMATION ON YOUR NEW STOVE	22
Convection	22
Glass system	22
CO ₂ and the environment	22
Shared flue	22
Ventilation	22
External air supply - Airsystem	22
FREQUENTLY ASKED QUESTIONS - FAQ	23
WARRANTY	24
DOWNCYCLING	26

Revision: 0
Date: 09-02-2026

We reserve the right to make printing errors.

CONGRATULATIONS ON YOUR NEW FIREPLACE INSERT

Congratulations on the purchase of your new wood-burning fireplace insert – and welcome to RAIS or attika! High quality, design and function go hand in hand in the fireplace insert you have selected.

For the latest tips, information and inspiration, follow us on our various channels:



We have put our hearts, souls and minds into each and every one of our products. We want you to enjoy using your stove for many years to come, so we have focused all our efforts on ensuring that this is possible.

You are now about to learn all about your stove – and turn your dream into reality. You will soon be enjoying using the stove in your home.

This user guide can help you get started with your new stove. You will receive an in-depth introduction to the following topics below:

- Wood
- Setting the damper and lighting your stove correctly
- Cleaning and maintaining your stove
- Frequently asked questions - FAQ

It is important for you to read up on all these topics so that you can get the maximum out of your fireplace insert. You can also return to the user guide if you have any problems or queries when you have been using your stove for a while. We hope you will find all the information that you need.

You can get in touch with your RAIS/attika dealer if you have any further questions.

It is important that fireplace inserts are used correctly for both environmental and safety reasons. Always make sure to observe all local precautions, including those referring to national and European standards, when operating the appliance.

Enjoy using your new fireplace!



Read and follow the user operating instructions.



Use recommended fuels.
• Type: Burning logs (I)



It is important for you to use dry, untreated wood and light the wood correctly so that your wood-burning stove can operate correctly. Which wood you should use and how to treat it prior to use are shown below.

USE APPROVED FUELS ONLY

General wood (wood that you have purchased or collected yourself) or pure wood briquettes are approved fuels. You must not use newspaper or similar as this will cause soot in your stove and give off contaminated smoke.

THE WOOD MUST BE DRY

If you can, bring in the wood a couple of days before you want to use it so that it is at room temperature. The wood must have a water content of 15-20%. In practice, this means your wood should be left to dry for at least one year (and ideally two) before you use it. As a result, it is a good idea to buy your wood early and organise good storage for it. Wood needs time to dry, and proper air drying can take up to 2 years depending on the type of wood and how it is stored.

Wood dries best when it is sawn and chopped. Place your wood in a well ventilated, sunny location protected from the elements, ideally under a lean-to or a woodshed, i.e. a shed with slatted sides. Avoid covering your wood, this will retain the moisture. Drying wood outdoors is almost always best because this ensures that plenty of air can circulate.

YOUR WOOD MUST FIT THE STOVE

The pieces of wood you use must fit the combustion chamber of your stove. Pieces of wood of a diameter greater than 10 cm should be chopped.

FUEL TYPE	Wood logs	
DESIGNATION	I	
LENGTH (RECOMMENDED)	Max. 30 cm	
STANDARD TEST FUEL	Beech, birch eller hornbeam	
MOISTURE CONTENT	12 - 25 %	



WARNING

Never use lacquered, laminated or impregnated wood, wood with a plastic coating, painted wood, chipboard, plywood, household waste, paper briquettes or coal. This may cause toxic smoke that smells unpleasant and causes contamination. Under no circumstances use any form of liquid fuel as this could cause an explosion. Your warranty will be rendered void if you burn non-recommended fuel in your stove and cause it to overheat.



WARNING

If you use incorrect wood or wood that is too damp, this may cause soot to form in the chimney, possibly leading to a chimney fire. If this happens, close off all air supplies to your stove if a valve connected to an AirSystem connection from outside is installed.



CALL THE FIRE SERVICE IF YOUR CHIMNEY CATCHES FIRE.

Never use water to put the fire out! Then contact a chimney sweep to check your stove and chimney.

RECOMMENDED AMOUNT OF WOOD FOR STOKING THE FIRE

The recommended amount of wood to burn after lighting depends on your stove model. Based on the nominal output of your stove, you can read the recommended amount of wood to use for refuelling.

By reading the CE labelling plate (or finding the output on our website), the stove has a nominal output of 8.6 kW, which means that the recommended amount of wood to be used when refueling is 2.25 kg divided into 3-4 pieces of wood logs. The stove is fired as intermittent operation and refuelling is done after 54 minutes.

NOMINAL OUTPUT	8.6 kW
RECOMMENDED VOLUME OF WOOD FOR STOKING	2.25 kg
MAX. KG OF WOOD PER HOUR	4 kg
WOOD LOGS	Max. 4
TIME INTERVAL FOR REFUELLING	54 min.

DO NOT OVERFIRE

Do not overfire the stove. The maximum volume of wood that may be burned in your stove is 4 kg. wood per. hour. It is important not to overfire, as this can cause damage to the stove.

LIGHTING YOUR STOVE FOR THE FIRST TIME

When you use your stove for the first time, it is best to light a small fire initially so that it “gets used to” the high temperatures. There may be a little odour and smoke due to the materials used in the stove – but this will soon disappear and it will only occur the first couple of times you light your stove. Make sure you allow this smoke to escape. The first time you light your stove, it is also recommended that you should open and close the door at regular intervals to prevent the seal on the door sticking.

If your stove has been left unused over the summer, for example, light a small fire the first time you start using it again. Your stove may give off a slight odour the first time you light it after any length of time.

NOTE:

Remember to open and close the door slowly when adding wood. This will not cause overpressure in the chimney and cause smoke to emerge into the room.

If you exceed the limits for the volume of wood specified in the table, the stove will be deemed overfired and will no longer be covered by the manufacturer’s warranty, as excessive heat can irreparably damage your stove.

TESTING YOUR STOVE

You can test how your stove is burning by checking:

- Is the ash pale or white?
- Are the walls of the combustion chamber soot-free?
- Is the smoke from your chimney almost invisible?

If you answer “yes” to all three of these questions, your stove is burning well.



REMEMBER!

When you use your stove for the first time, it is important for you to vent it while the paint settles (the stove gives off an odour and a small amount of smoke). This process may be repeated the first couple of times you use your stove. This will decline when your stove has reached its maximum temperature. Avoid touching the paint on your stove before lighting it for the first time and before the stove has cooled completely.



It is worthwhile spending some time finding out how best to operate the damper on your stove. This will ensure your wood burns as effectively as possible and gives you the most beautiful fire.

MANUAL AIR DAMPER ADJUSTMENT

The three settings on the damper are adjusted by rotating it from side to side.

POSITION 1.

The damper on the stove is set to fully open at start-up. Push the damper all the way to the right. The air damper is fully open and provides full air when starting your stove. This position is solely for use when starting your stove (approx. 10-20 minutes) and refueling and is not used during normal operation.

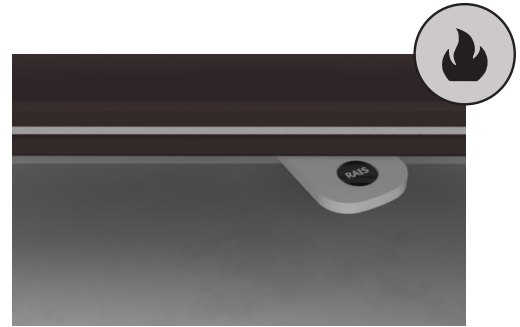

POS 1 - STARTUP

POSITION 2.

The damper closes slightly as the fire takes hold. Push the handle to the left to the first "notch". This is the central position. During regular burning, we recommend placing the damper between position 2 and 3. When the damper is set correctly, the flames are clear and yellow.

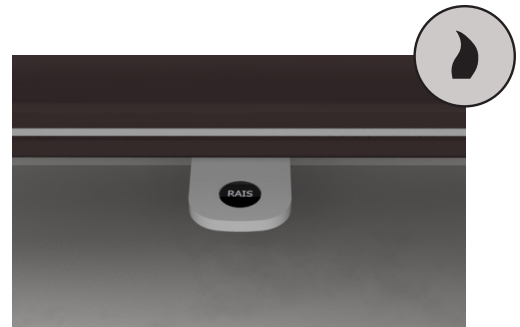

POS 2 - IN OPERATION

POSITION 3.

Push the handle all the way to the left. The air damper is closed, which keeps the air supply to a minimum. This setting should be avoided while your stove is operation, but it can be used when your stove is not in use.

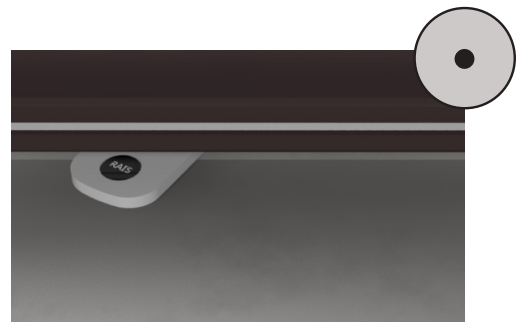

POS 3 - CLOSED

Combustion in your stove will be poor if it is not getting enough air, and in a worst-case scenario this may result in unburnt fumes, smoke, inefficient use of the wood and less heat. A dark smoke will emerge out of the chimney. The smoke from the chimney is almost invisible if the wood is burning correctly.

REMEMBER!

If you find your stove is getting too hot you should not turn the damper down all the way – instead, you should vent the stove. You cannot adjust the heat in the room using the damper – only the amount of wood you use can affect this.



WARNING

Never use petrol, lamp oil, kerosene, charcoal lighter fluid, ethyl alcohol or similar liquids to start or "re-ignite" a fire in the heater. Keep all such liquids well away from the heater while it is in use.



IGNITION AND REFUELLING

Follow the instructions 1-5 below for correct ignition and use of the stove.



You should **never** open the door when the flames are high, as they can damage the paint on the stove.

- ① Begin by stacking 12 pieces of split firewood in layers of four at the bottom of the stove. Place the ignition bags between layers 2 and 3, as shown in the image. Place the remaining two sticks. The split firewood should measure about 4x3x23 cm. It is critical that there is air between the pieces; otherwise, the fire will struggle to take hold.

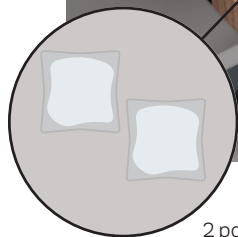
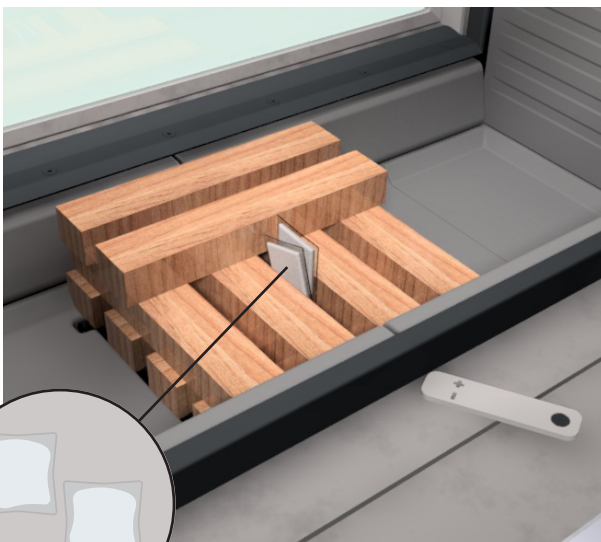

2 pcs ignition bags



WARNING
During use, the fireplace insert becomes hot, particularly the exterior surfaces, and should be handled with caution. Therefore, use gloves.

- ② Set the air damper to the open position. Light the fire by igniting the two ignition bags placed between the layers.

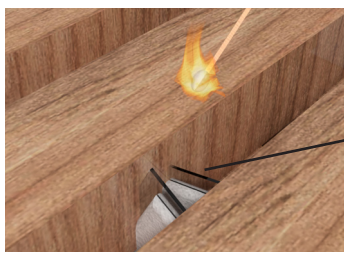
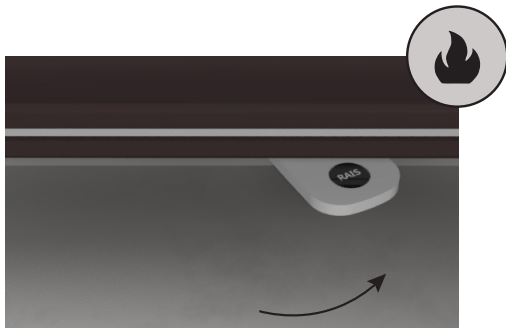

Igniting the ignition bags

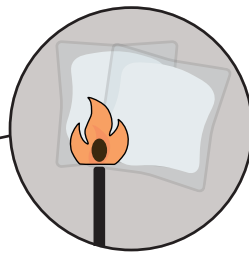

NOTE! - It is important to get the wood burning quickly.

- ③ When the fire has a firm grip on the sticks, set the air damper to the centre position.

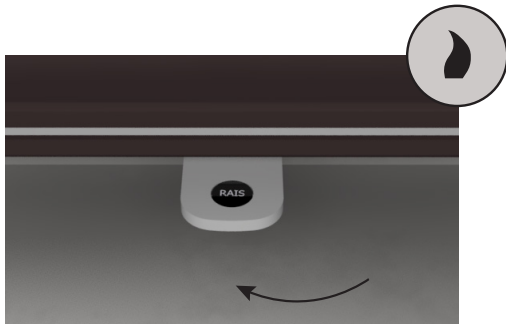

WARNING

To ensure safe combustion, the flames must be clear and yellow or the embers must be clear – the wood must never sit and “smoulder”. If the fire is merely smouldering or smoking and insufficient air is supplied, this will cause uncombusted fumes to form. Fumes may ignite and explode. This may cause damage, and potentially injure people.

THEREFORE, NEVER CLOSE OFF THE AIR SUPPLY ENTIRELY WHEN LIGHTING YOUR STOVE.



- ④ When the last flames have died and there is a nice layer of embers, add two to three pieces of wood. Only add new firewood when there are only embers in the stove, NOT when there are flames and while the fire is in full flame.

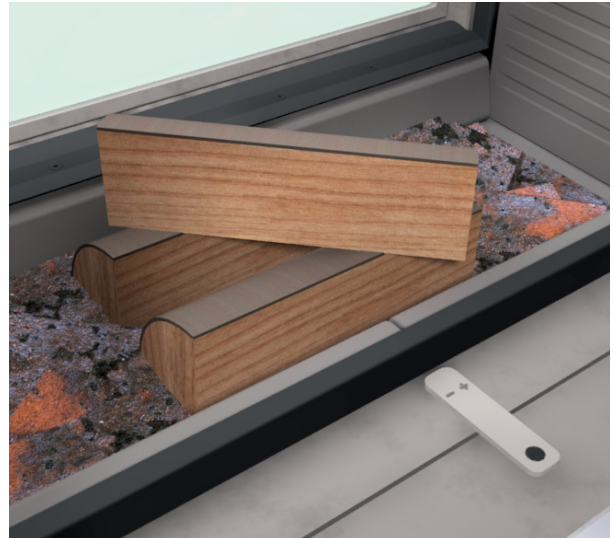
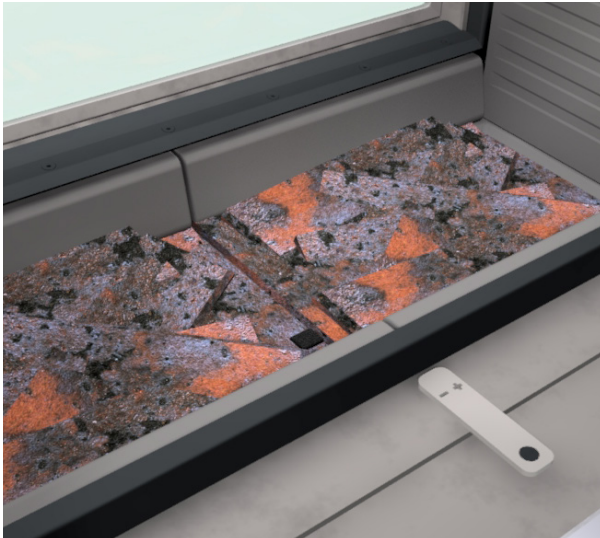

If the fire has burned down too far and there is not enough embers, start the lighting process all over again.

- ⑤ After 5 minutes - or when there are clear yellow flames - gradually close the damper. However, do not close the damper completely until the combustion process is complete and there are no more embers in the stove.

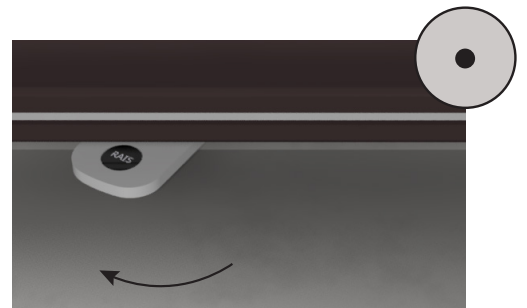
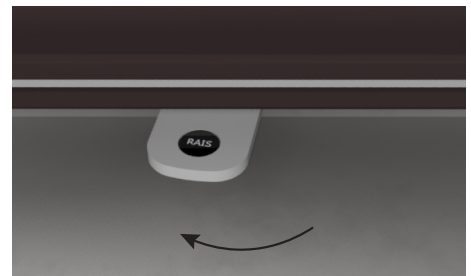

The door should always be kept closed except during firing and fuelling. If the stove is cold and the window has condensation, it may help to leave the door ajar for 2-3 minutes during firing or loading to ensure that the fire gets a good grip and sufficient heat enters the chamber. However, it is important to always follow and observe local precautions, including those referring to applicable national and European standards, when operating the stove.

DISTANCE TO FURNITURE

DISTANCE TO FURNITURE

Ensure that flammable objects (e.g., furniture) are not closer than the distances specified in the table (fire risk).

	DISTANCE TO FURNITURE (MIN.)
From front door	1200 mm
From side	350 mm



WARNING

It is important to observe these distances to combustible material as radiation, especially through glass surfaces, can ignite flammable objects around the stove.



CLEANING THE FLUE

It is important to regularly clean the stove and the flue to check for blockages before lighting. Especially before a new firing season, after a longer period without using the fireplace insert.

To access the smoke path, carefully remove the two lower smoke deflector plates, the four upper smoke deflector plates, and the lower and upper steel chicanes.

1. Remove the lower smoke deflector plates by carefully pushing the rear edge upwards. Then lower the front edge and remove the plates.
2. The upper smoke deflector plates rest on a bracket; push them upwards, tilt them and lower them to remove them.
3. The lower and upper steel baffles are removed by lifting and tilting them, after which they can be taken out.

Then carefully insert them in reverse order.

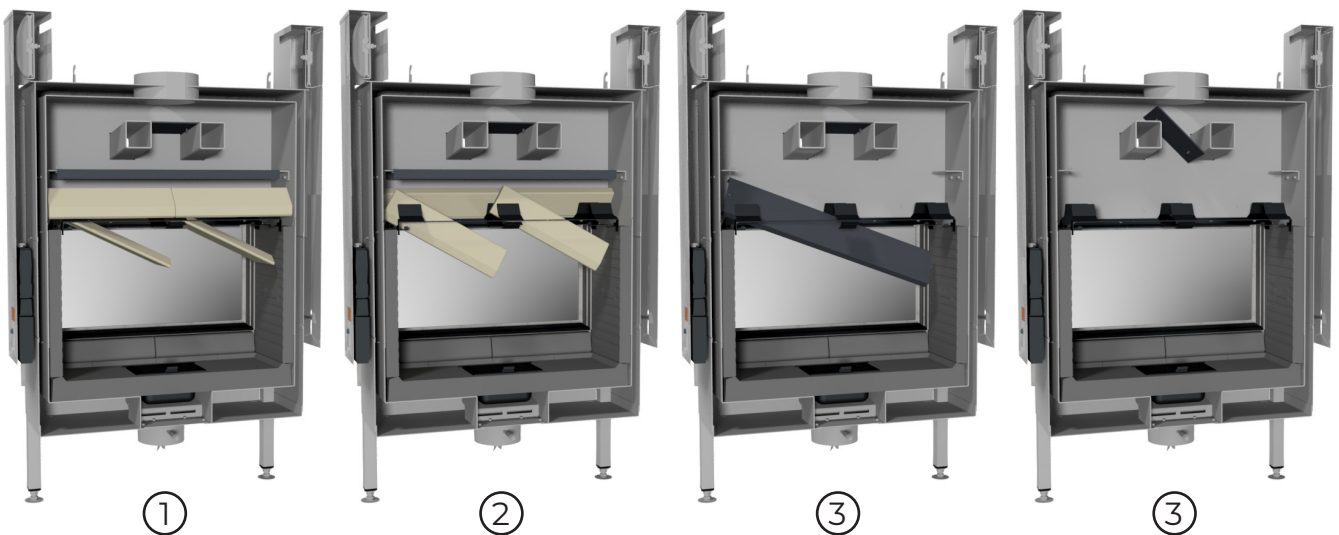
**WARNING**

Smoke from blocked chimneys is dangerous. Always make sure the chimney and flue pipes are free of blockages and clean according to instructions. Use only recommended fuel for clean combustion and safe operation.



REMOVING THE COMBUSTION CHAMBER LINING

The combustion chamber lining protects the wood burning stove against the heat from the fire. The large temperature fluctuations can cause cracks in the plates, which, however, do not affect the functionality of the stove. The plates only need to be replaced when they begin to crumble after several years of use. The plates are only laid or placed into the stove, and can thus be replaced without problems by you or your dealer.

Removal of the combustion chamber lining is done in the following order.

1. Before the firebox liner can be removed, the grate and ash pan must be removed.
2. Remove the smoke deflector plates (1), see the section on cleaning the flue.
3. Remove the bottom plates (2) & (3).
4. The side plates (6) can now be removed by pulling them out at the bottom.

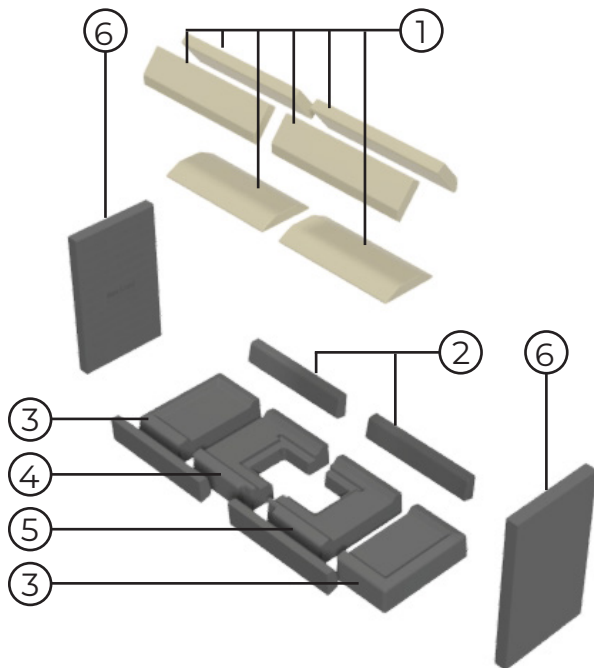

Carefully insert again in reverse order.

When using your stove, it is important for you to know how to maintain it. This section describes how to clean and maintain your stove.

CLEANING THE OUTSIDE OF YOUR STOVE

When cleaning the outside of your stove, how you go about this is dependent on the colour of the stove and what it is made of. The table below shows how to clean your stove.

NOTE: Your stove must only be cleaned when cold.

It is important to clean your stove regularly. If dirt and stains are left on the stove (particularly in pale areas), there is a risk of the stains being burnt on.

If you need to maintain the surface, all colours are available as spray paints. If general cleaning is not enough to remove any discolouration, please contact your RAIS/attika dealer.

STOVE COLOUR	PROCEDURE
White Nickel Platinum Sand	Wipe with RAIS Stove cleaner or warm, soapy water (washing-up liquid)
Sort Mocha	No liquids. Wipe with a wrung-out cloth.

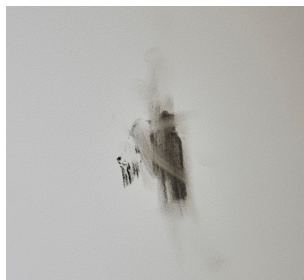

TIP! - We recommend that you always use regular, mild detergents for cleaning your stove. Always test a detergent in a non-visible location (behind the stove, for example) before cleaning.

CLEANING OF COMBUSTION CHAMBER

The combustion chamber is emptied of ash as needed. You can carefully take the ashes out with a small hand shovel, or sweep it through the grate into the ash tray. The ash must be completely cooled before it is discarded, as it can still store itself glows in it for up to two days. Open the grate to access the ash drawer, see picture below. Remember to use a glove when the fireplace insert is hot. Never completely empty cover the firebox with ash, as the fire burns best with a small layer of ash.

Scrape/shovel the ash into the grate in the centre of the fireplace insert. The ash drawer underneath the grate can be removed and emptied in a non-combustible container until it has cooled off. Ash can be disposed of as ordinary household waste.

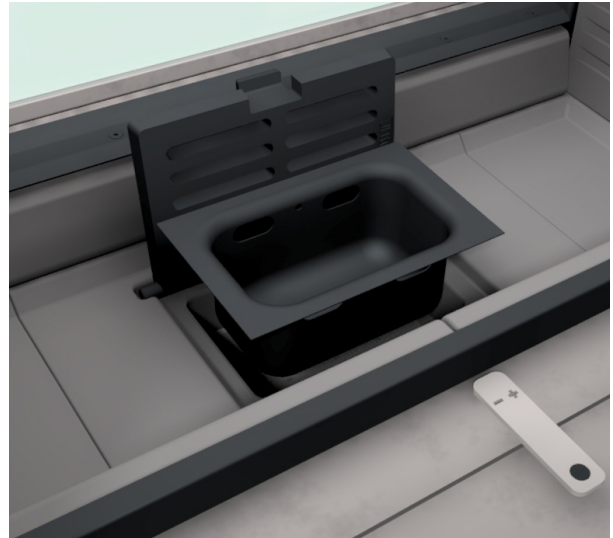
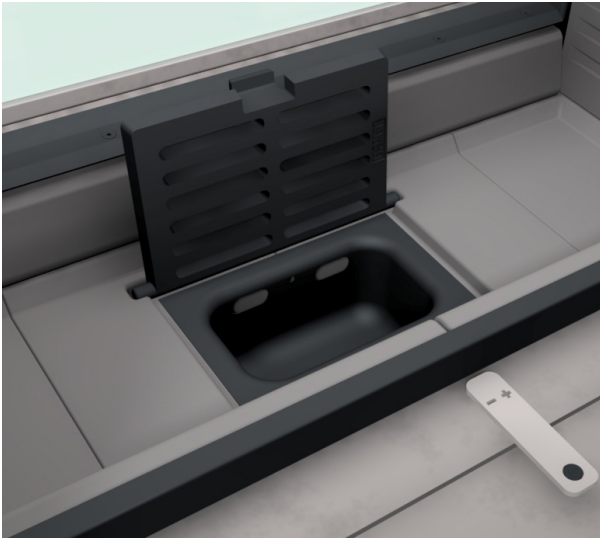

CLEANING THE GLASS

First, lock the door using the special key supplied with the stove. There is a door lock above the door, which must be turned outwards.

The door is hinged at the bottom and now tilts forward so that the glass can be cleaned. Press lightly on the handle to tilt the door forward.

After cleaning, close the door and lock the door lock again.



Door lock Closed

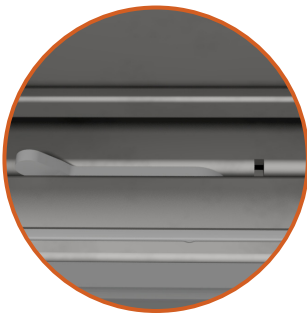

Door lock Open

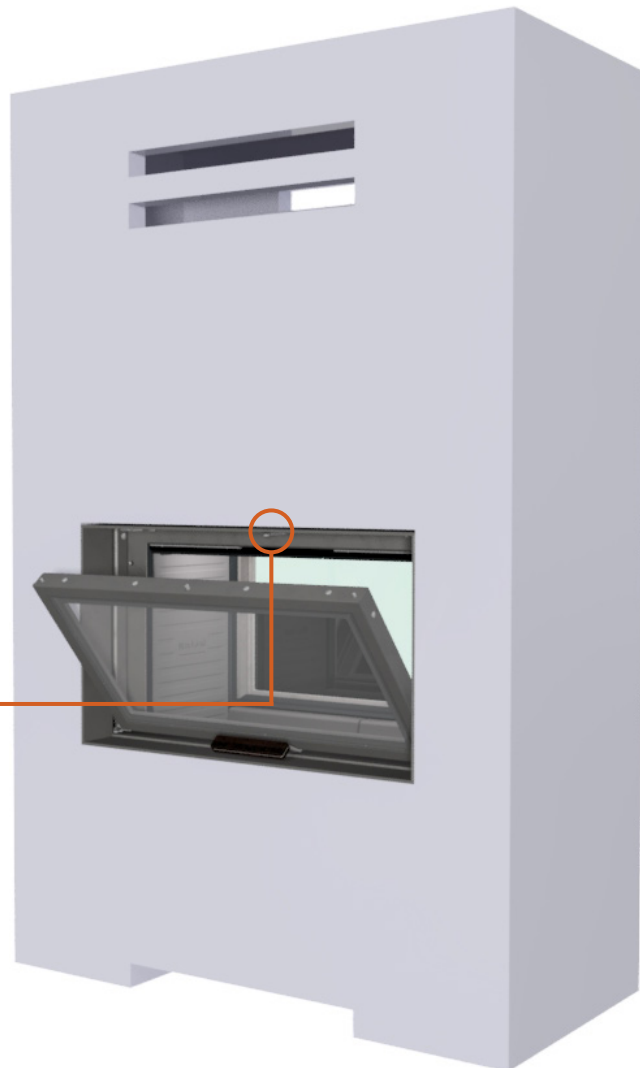
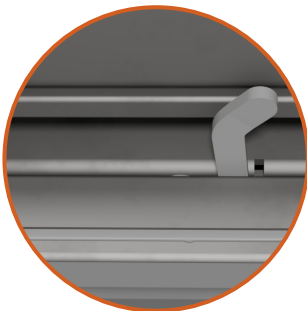

CHECKING THE CHIMNEY

The chimney is what makes your stove work. Remember – even the best stove will not work perfectly unless the chimney is drawing correctly and to the necessary extent. The chimney and flue collar must always be checked for blockages before each new heating season. Your chimney sweep should check both the chimney and your stove at least once a year. You should always contact your chimney sweep if you are in any doubt as regards the condition of your chimney.

If there your chimney is drawing too much, fitting the chimney or flue with a regulating damper is recommended. Contact your dealer.

REPLACING SEALS

Inspect your stove for damage regularly, both inside and

out, in particular the seals and heat insulating plates. The seals must be replaced if they are worn or fractured.

MOVING PARTS

Lubricate the door rails and their bearings as needed with lubricating spray, but it is important to lubricate continuously so that it is not only done when the damage has occurred. Before spraying lubricant into the rails, place a cloth under the rails to collect excess lubricant. After lubrication, move the door up and down 10-15 times and lubricate again to ensure that it gets into the bearings. The brackets for opening the glass should also be lubricated continuously. We recommend that our lubrication spray is used exclusively, as the use of other products can lead to the formation of odours and residues. Contact your dealer to get the lubricant.

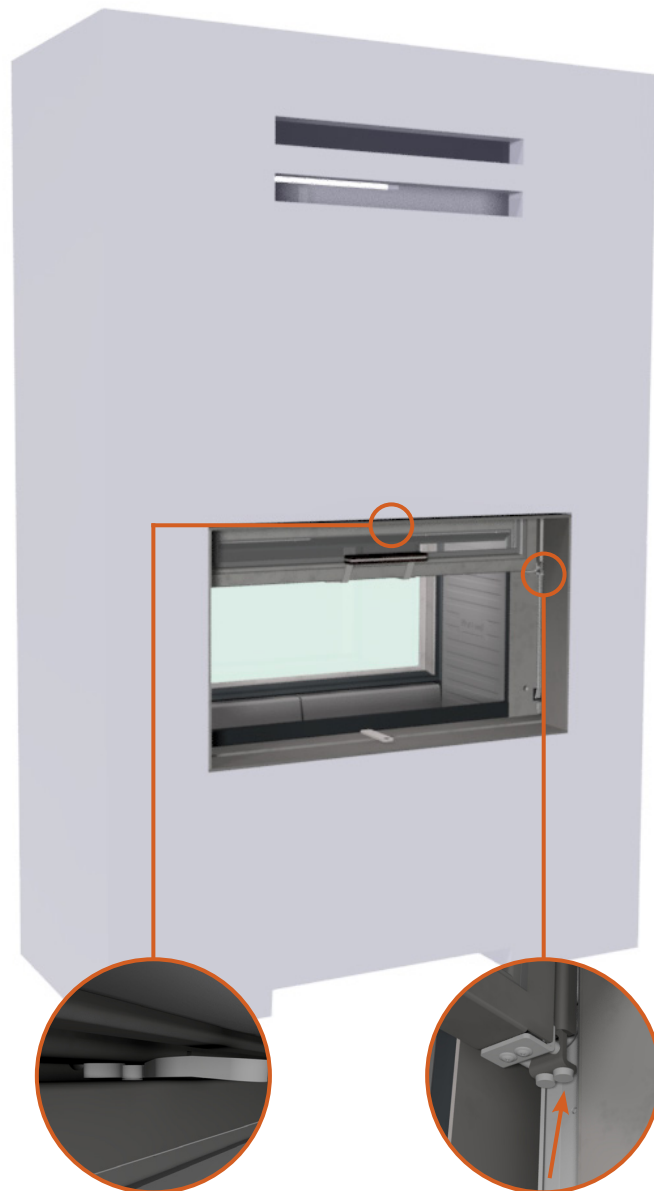

GUIDE TO NOMINAL TEST FIRING

Perform the test as described below if you want to do a nominal test firing. Follow the instructions 1-3 below for ignition and pre-firing before test firing, where the results are measured. Pre-firing is used to raise the temperature inside the combustion chamber before measurement and to create a good base glow layer. The interval before refuelling is 54 minutes.



2.25 kg



230 mm



54 min.



ENG

1 IGNITION

Ignition is done in the same way as the instructions for ignition on pages 8-9. Start by placing 12 pieces of split firewood with a total weight of approx. the test charge in layers of 4 in the bottom of the stove. Close the door ajar for 5 minutes and set the damper to the open position for 5-10 minutes. Then set the damper to the centre position.

⌚ 5 min.



⌚ 5 - 10 min.

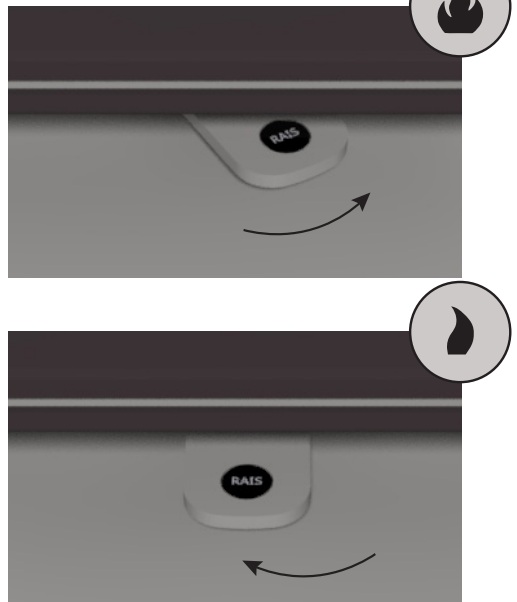

The damper is then set in the centre.

2 PRE-FIRING

Pre-firing is done to bring the temperature up inside the combustion chamber before the final test. Pre-firing is done in the same way as the test firing. Therefore, see point 3 for a description of filling and operation. Pre-firings are done before the test firing is started to achieve a basic glow layer of about 360 g. From here, about 5 test cycles are run, with each test cycle ending when the weight is about 60 g higher than the previous cycle. The criterion is that the weight at the end of the cycle must not differ by more than 100 g from the previous cycle.

3 TEST FIRING

Place 3 pieces of birch wood without bark with a total weight of approx. 2.25 kg (divided equally between the three pieces of wood). The wood should have a length of 230 mm and a square, cross-section. Close the door immediately after filling. Set the damper to fully open for 1.5 minutes, then to the middle position. After a total of 3 minutes, the damper should be carefully set between the middle position and the closed position for the remainder of the test.

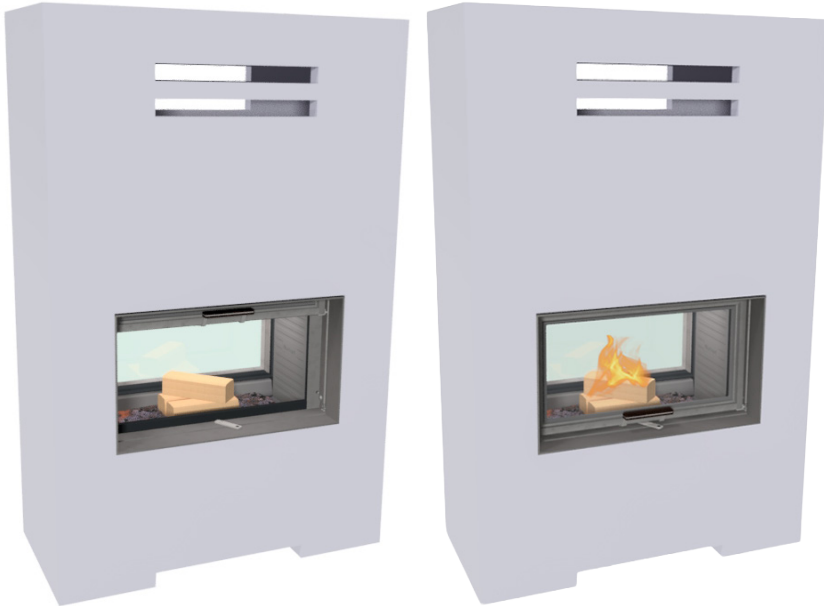

It is important that the three pieces of birch wood are placed centrally in the stove and according to the instructions. The bottom sticks are placed centrally with 20-30 mm between them. The last stick is placed diagonally on top of the others.

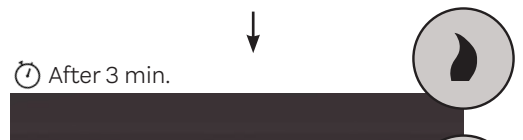
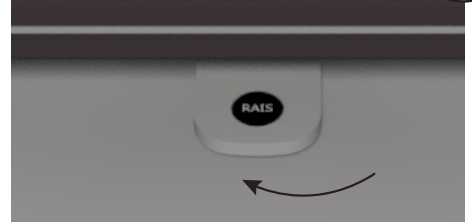
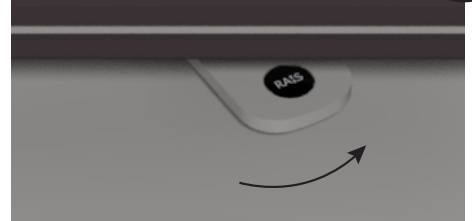
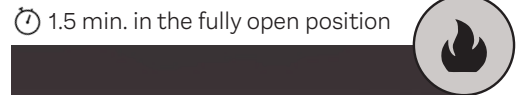
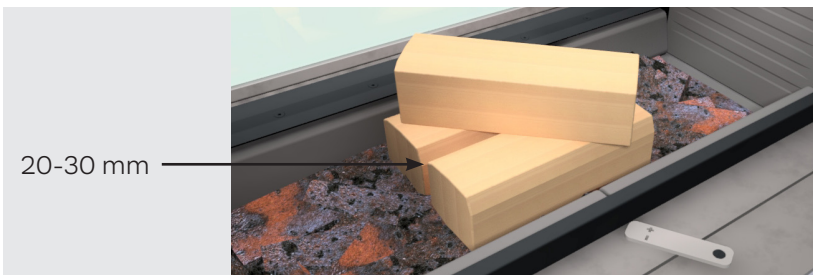

The damper is adjusted between the centre position and closed position*.

To achieve test results similar to those shown, it is important to set the damper correctly during use. Below is the exact position of the damper. Move the handle gently in a sliding motion.

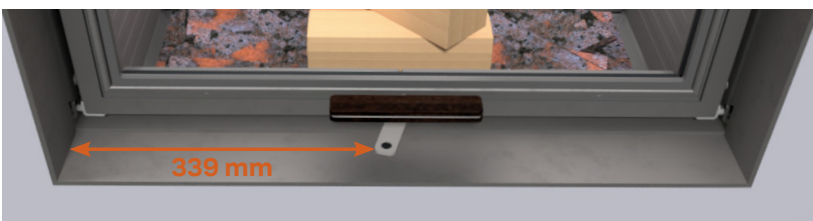

*The precise adjustment of the damper between centre and closed position is 339 mm from the edge of the frame to the edge of the damper handle.

SPECIFICATIONS

DTI Ref.: 300-ELAB-2241-EN

		Nominal	Standard: EN16510-2-2:2022
		Wood logs	Fuel
P	kW	8.6	Nominal heat output
P _{SH}	kW	8.6	Space heat output
η	%	≥ 75	Efficiency
η _s	%	≥ 65	Seasonal space heat efficiency
EEl	-	106	Class A Energy efficiency index
CO (13% O ₂)	mg/Nm ³	≤ 1500	CO emission at 13 % oxygen content
NO _x (13% O ₂)	mg/Nm ³	≤ 200	NO _x emission at 13 % oxygen content
OGC (13% O ₂)	mg/Nm ³	≤ 120	Hydrocarbon emission at 13 % oxygen content
PM (13% O ₂)	mg/Nm ³	≤ 40	Particulate matter emission at 13 % oxygen content
p	Pa	12	Minimum flue draught
s	mm	50*	Material type and thickness of protective insulation
T _s	°C	316	Flue gas outlet temperature at the flue pipe collar
Tclass	-	T400 G	Chimney designation according to the appropriate chimney standard
Φ _{f,g}	g/s	8.1	Flue gas mass flow
V _h	m ³ /h	0	Standing air loss
CON or INT	-	INT	Intermittent operation (INT)
t	min	54	Fuelling time
M _a	kg	2.25	Recommended wood quantity when filling (Divided into 3-4 pieces of firewood)
d _{out}	mm	200	The diameter of the flue pipe collar
L, W, H	mm	959 x 552 x 1475	Overall dimensions of the appliance (length, width, height)
L _c , W _c , H _c	mm	688 x 230 x 210**	Combustion chamber (length, width, height)
m	kg	235	Mass of the appliance
Type	-	BE	Appliance intended to be supplied with combustion air via a combustion air duct

*The material (panels/brick) needs to be complied with an insulation value greater than 0,03 m² x K/W. For more information about installation materials, see the installation section in the installation manual.

**Max. load limit

The fireplace insert was tested and approved by:
 DTI - Danish Technological Institute
 Teknologiparken Kongsvang Allé 29
 8000 Aarhus C, Denmark
 www.dti.dk
 Tel.: +45 7220 2000

Set-up distances		Visio 2:1	
d_R	mm	-	Minimum distance from the back of the installation box to combustible material
d_S	mm	350	Minimum distances from the sides to combustible material
d_C	mm	250	Minimum distance from top convection opening to combustible material in the ceiling
d_P	mm	1200	Minimum distances from the front to combustible material (Distance to furniture)
d_F	mm	0*	Minimum distances from the front to combustible material in bottom front radiation area
d_L	mm	0*	Minimum distances from the front to combustible material in side front radiation area
$d_{B'}$	mm	475	Minimum distance from the bottom edge of the door to the floor.
d_{non}	mm	0	Minimum distances to non-combustible walls
			Read and follow the user operating instructions

*0 mm: Since 65 K is not exceeded by radiation on the floor in front and/or on the side wall. Cf. EN16510 Note 3.

Read the section about installation distances in the installation manual.

CONVECTION

All RAIS/attika stoves are convection stoves. Essentially, convection is all about the distribution of heat throughout the room. A convection stove is good at circulating hot air throughout the room. Cold air is drawn in at the base of the combustion chamber and heated. The hot air then rises and flows out at the top and creates circulation in the room. Convection ensures that heat is distributed evenly and comfortably throughout the room. Be aware that all exterior surfaces will be hot, so do not touch the stove when it is lit.

GLASS SYSTEM

All RAIS and attika stoves come with a glass system, which means that hot air flows down over the glass and removes any soot residues. This happens when the fire is burning correctly and there is a high level of combustion in the stove.

CO₂ AND THE ENVIRONMENT

You may also be wondering how your new stove will affect the environment, and not least your CO₂ emissions. Burning wood is regarded as CO₂-neutral, as the amount of carbon dioxide emitted when wood is burnt correctly is equivalent to the amount of carbon dioxide that the tree would have given off as it decayed in the forest.

As regards the environment, all RAIS stoves do of course meet the very strictest requirements in terms of efficiency and discharge of residual particles, and they are at the very front of the field in the European market

when it comes to eco-friendliness. We are constantly working to develop and optimise combustion, and work in partnership with organisations such as the Danish Technological Institute.

VENTILATION

The stove needs permanent and sufficient air to operate safely and efficiently. A permanent air supply can be installed in the room for the stove's combustion air - through the AirSystem connection. Under no circumstances should this air supply be closed during operation. Note that any mechanical extraction such as a cooker hood can reduce the air supply. The stove has an air consumption of min. 23.5 m³/h.

EXTERNAL AIR SUPPLY – AIRSYSTEM

If you live in a low-energy building, your home is insulated or you just live in a recently built house, you may find it necessary to provide an air supply from outside and directly into the stove. This may also be necessary if there is vigorous extraction near to your stove, such as an extractor hood. This external air supply is what we call AirSystem. All our stoves have the option of providing an external air supply. If there is no external air supply, the stove uses air in the room for combustion instead. With AirSystem, the air is taken from outside.

SHARED FLUE

IMPORTANT! it is **NOT** allowed to connect multiple stoves to the same chimney in the **UK**.

In other countries it is permitted to connect several stoves to the same chimney, provided that the two stoves have the same owner, as in an example where a house has two floors with one stove in the living room and one on the first floor. It is a requirement that the inlets must be positioned so that there is a clearance difference between them of at least 250 mm. This is only allowed if the door is self-closing, so read the relevant section in the installation manual carefully.



WHY IS MY STOVE NOT BURNING THE WAY IT SHOULD?

In most cases, we find that stoves do not burn the way they should because of the way they have been let. Please read the section entitled "General information on lighting your stove" carefully before getting started. There are three things in particular that cause stoves not to burn correctly:

- The damp is open too far (it should only be fully open during the initial phase, i.e. for 5-10 minutes).
- The door is opened too quickly after lighting the stove. Be patient and allow the fire to die down so that just glowing embers are left before you add more wood.
- You are not using enough wood, or the wood you are using is too thick or too wet. It will be difficult to get your chimney to draw if the wood is not burning as it should.

WHY IS MY STOVE MAKING "CLICKING NOISES"?

Little clicking noises are normal when the stove is in use. This is due to hot materials expanding.

WHY DOES THE GLASS TURN BLACK?

This may be because your wood is too wet or the damper on the stove is adjusted too far down. Check how damp your wood is, and make sure you give your stove enough air when lighting it before closing the door so that the stove warms up properly.

WHY IS SMOKE COMING OUT OF THE DOOR?

This may be because your chimney is not drawing properly. Check whether the flue or chimney is blocked. If your stove is situated near to the kitchen, check whether the extractor hood is switched on – if it is, switch it off and open a window near to the stove for a short time. This smoke may also appear if you open the door too quickly when adding new wood. Try opening the door more slowly.

WHY IS MY STOVE GIVING OFF AN ODOUR?

The stove may begin to give off smoke and odour if there is insufficient oxygen for combustion. Allow more air into your stove using the damper.

WHY IS MY STOVE GETTING TOO HOT??

You should not adjust your damper downwards if you find your stove is giving off too much heat in your room. The temperature can only be controlled by adjusting the amount of wood you use. Use less wood and vent the room.

WHY IS MY STOVE COVERED IN SOOT ON THE OUTSIDE, ABOVE THE DOOR?

Set on the outside of the stove is usually due to opening the door while there are still tall flames in the combustion chamber. Always wait until the fire has burned down before opening the door. This may also be caused by opening the door too quickly. Always open the door slowly and carefully. However, please be aware that it is not possible to prevent a small amount of ash and soot emerging when you use the stove.

WHY IS MY STOVE BURNING TOO FIERCELY?

If your stove is burning too fiercely, this may be due to a leak in the door seal. This has to be replaced as stated in the installation guide. It may also be due to your chimney drawing too much. In this case, a regulating damper should be fitted. You can ask a chimney sweep, fitter or dealer to come to your home and check whether your chimney is drawing correctly.

WHY IS MY STOVE NOT BURNING SUFFICIENTLY?

If your stove is not burning sufficiently, this may be due to several things: insufficient wood, insufficient supply of air to the ventilation in the room, failing to clean the flue, a leaking chimney or a leak between the chimney and the flue.

WHAT CAN I DO IF MY CHIMNEY IS NOT DRAWING PROPERLY?

If your chimney is failing to draw properly, this may be due to many different things:

- Too low a temperature difference – if your chimney is insulated poorly, for example.
- A high outdoor temperature (in summer, for example)
- No breeze
- The chimney is positioned too low and in a sheltered location
- The wrong air in the chimney
- The chimney and flue are blocked
- The house is too "sealed" (no fresh air supply)
- Negative smoke extraction (when the chimney is drawing poorly)

A cold chimney or difficult weather conditions can be compensated for by supplying more air to the stove than usual. If your chimney is continuing to malfunction, we recommend that you contact your dealer or chimney sweep.

I AM ENCOUNTERING OTHER DIFFICULTIES WITH MY STOVE

Many queries or issues relating to the use of stoves are down to local conditions (such as draughts, for example) If you are experiencing a problem for which no answer is given here, please contact your RAIS/attika dealer.

WARRANTY

RAIS or attika issues warranty on all models, commencing from the date of installation. We have already invested a great deal of effort in our inspection processes and looked at the quality of materials, manufacture and product safety.

THE WARRANTY DOES NOT COVER WEAR PARTS:

- Door and glass seals
- Ceramic glass
- Combustion chamber lining
- The surface appearance or the texture of natural stone
- The appearance of the stainless steel surfaces and colour changes
- Expansion blemishes

THE WARRANTY WILL BE RENDERED VOID IF:

- Your stove has been damaged due to overfiring
- Damage has been caused by external stresses
- Unsuitable fuel types have been used
- There has been failure to comply with statutory or recommended installation instructions
- You have made alterations to the stove yourself
- Your stove has not been serviced or maintained
- Using spare parts other than those recommended by RAIS/attika will invalidate the warranty. All interchangeable parts can be purchased as spare parts from your RAIS/attika dealer.

WARRANTY ON THE WEBSITE

Select your preferred language on the website.

PLEASE CONTACT YOUR DEALER IF YOUR STOVE IS DAMAGED.

If you make a claim on the warranty, we will decide on how the damage is to be remedied. If it is to be repaired, we will ensure that the repairs are carried out professionally.

Please see national and EU laws and regulations on renewed warranty periods in the case of warranties on repaired parts or parts supplied later. The applicable warranty terms and conditions are available from RAIS or attika at any time.

**WARNING**

For safety reasons, do not make unauthorised modifications to the stove. Only recommended spare parts may be used. The stove has been tested and approved with the recommended spare parts, and therefore RAIS/attika cannot be held responsible for safety in the event of modifications that contravene the recommendations.



SPARE PARTS

If you need new spare parts for your product, you can scan the QR code to see which spare parts we offer. If spare parts other than those recommended by RAIS are used, the warranty will be cancelled. All interchangeable parts can be purchased as spare parts from your RAIS dealer.



DOWNCYCLING

When your stove is no longer usable in the distant future, it is important that it is sorted correctly. Below is an overview to help you on your way. A deeper description of the symbols can be found via the QR code.

DOWNCYCLING OF PACKAGING

Do you need to know how to dispose of the packaging that the stove comes in. Scan the QR code for packaging disposal.



ENG

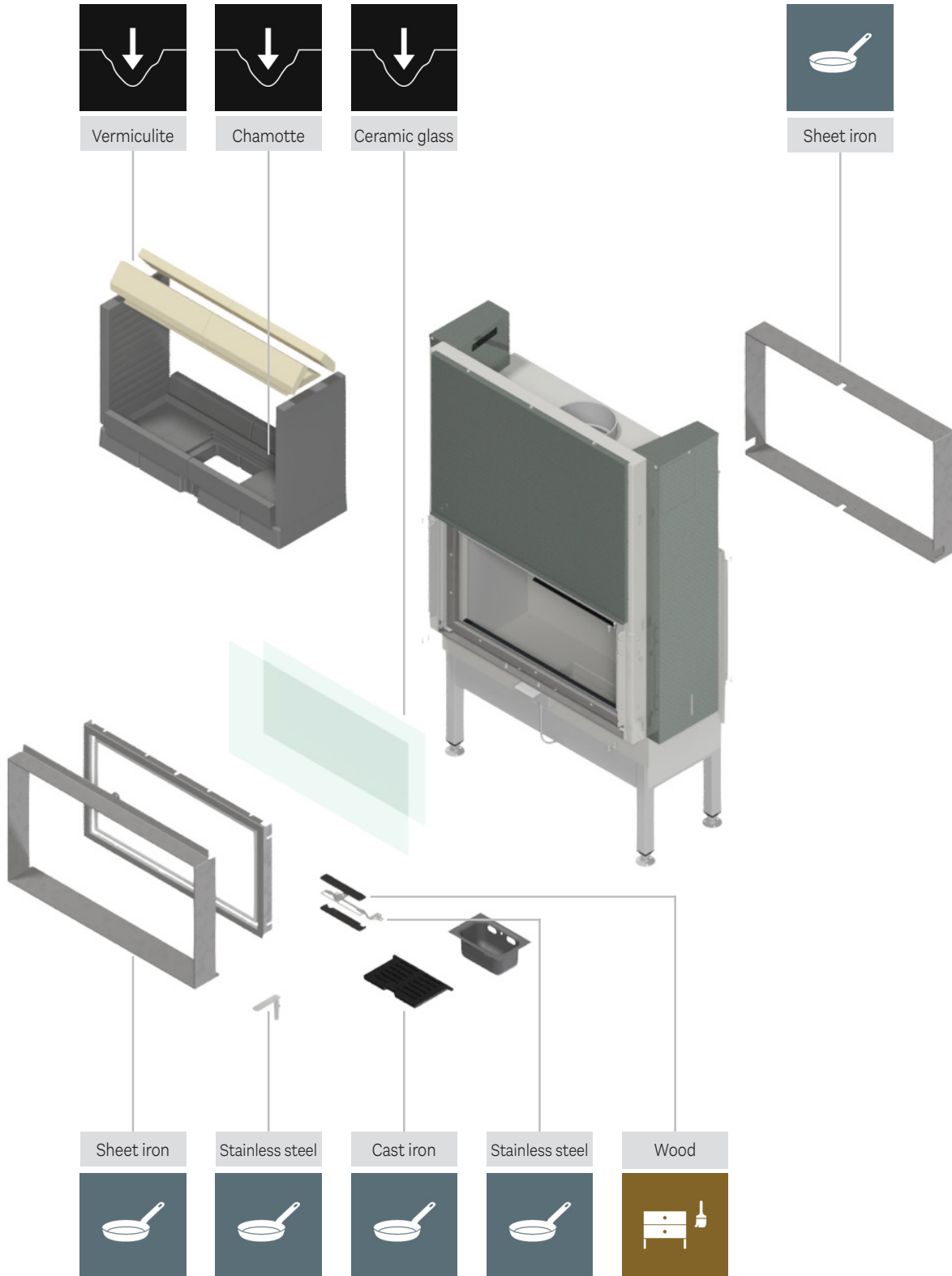



Article number: 1256521ENG



5 708252 449275

RAIS[®]

RAIS A/S
Industrivej 20
DK-9900 Frederikshavn
Denmark
www.rais.com

attika[®]
FEUERKULTUR

ATTIKA FEUER AG
Brunnmatt 16
CH-6330 Cham
Switzerland
www.attika.ch